

Genetic Algorithm Based Trajectory Stabilization of Quadrotor

Mukul Gaur

DCRUST, Murthal, India

Himanshu Chaudhary

Department of Electrical Engineering,
Jamia Millia Islamia, New Delhi-25, India
himanshuchaudhary.h@gmail.com

Shahida Khatoon

Department of Electrical Engineering,
Jamia Millia Islamia, New Delhi-25, India

Ravindra Singh

Scientist 'G', LASTECH, DRDO,
New Delhi, India

Abstract - This paper deals with control and stabilization of a quadcopter UAV using Genetic algorithm tuned PID controller. In this work, conventional GA is improved in two ways: firstly, crossover fraction and mutation rate is made adaptive by using a Fuzzy logic controller. Secondly, an advanced randomness is provided in GA by changing half of its initial population with random candidates after a fixed generations. Simulation results proven to be more optimized with the proposed controller in respect to the both transient response and robustness in presence of adverse condition or disturbances.

Keywords — *Quadcopter, Dynamic Modeling, PID Controller, Genetic Algorithm (GA), Modified Genetic Algorithm.*

I. INTRODUCTION

Unmanned aerial vehicles (UAVs) are capable of flight with no pilot on-board. They can be controlled remotely by an operator or autonomously via pre-programmed flight paths. These are used by the military, as tools for search and rescue operations, warrant continued development of UAV technology. Recently, Non-military use of UAVs has also increased. Some of them are: Pipeline/power line inspection, border patrol, search and rescue, oil/natural gas searches, fire prevention, wild life management, aerial photography and film making, topography and agriculture etc. [1]

Lift of quadcopter is generated by four motors. Control of such a craft is accomplished by varying the speeds of these motors relative to each other. Hence, it demands a sophisticated control system to allow for a balanced flight, as the dynamics of such a system require constant adjustment of four motors simultaneously. The goal of this work is to design a robust and efficient control system for quad-rotor controlling.

For this purpose, a number of control strategies have already been used. The main quadrotor control methods used in the literature are: Linear Quadratic Regulator (LQR) [2], proportional – integral – differential (PID) [2], control methods based on adaptive techniques, backstepping control [3], dynamic feedback [4], control strategy based on visual feedback [5] etc.. Some of these require lot of computation while other need an exact model of the quadcopter. In this paper, we have used PID controller for quadcopter control. PID controller has simple structure & its performance has already been tested for various processes. Its parameters also can be easily tuned for optimal performances [6].

Genetic algorithm GA is a versatile method in the field of optimization over the past few years & have already been used

to solve the optimization problems with minimal problem information [7] e.g. Task of tuning of PID controller [8], evolving the structure of Artificial Neural Networks [9] & evolving the structure of Fuzzy Logic Controllers [10], Economic Load Dispatch Problems [11] & many other optimization problems. Elitism, arithmetic crossover & mutation operators are main operations of GA.

GAs perform global searches, but their long computation times limit them when solving optimization problems on large scale. In this work, an improved Genetic Algorithm has been proposed. Fuzzy logic controllers have already been used to get adaptive crossover and mutation rates of GA [12]. The same technique is being used in this work. But, the structure of the FLCs used is different w.r.t the membership functions. Moreover, to enhance the randomness in the algorithm, half the initial population is generated randomly after five generations [9]. Results show an up gradation in over-all performance using the designed algorithm. The paper is organised as follows: Section I deals with the Introduction and diverse application of Quad-rotor, In section II, Quad-rotor model along with its complex dynamics is presented, Section III presents modified genetic algorithm integration with designed Quad-rotor model, followed by simulation results study & concluding remarks at last.

II. QUADROTOR MODEL

In this section, a brief summary of quadrotor model used in this work has been discussed. Figure 1 shows the theoretical model of quadcopter. Quadcopter is multi-input multi-output dynamical nonlinear system. A highly complex set of equations with their derivations can be found in [1]. Also simplification of these equations is presented in [13]. Each rotor produces moments and vertical force. These moments have been observed to be linearly dependent on the forces at low speeds. Since there are four input forces and six output states $(x, y, z, \psi, \theta, \phi)$ the quad-rotor is an under actuated system and thus modelling a vehicle such as quadrotor is not an easy task. Therefore, the aim is to develop the model as much realistic as possible.

The sum of the thrust of each rotor is the collective input (U1). As, the input is the thrust generated by the four rotors which are fixed, different movements of the quadcopter are obtained by increasing or decreasing the speeds of various motors. The quad-rotor dynamics are determined from a set of equations of motion. The complexity of equations increases with increase in accuracy. There are six degrees of freedom of a rigid body movement: of which three define the reference position

(usually the centre of mass), and the other three defines the orientation of the vehicle.

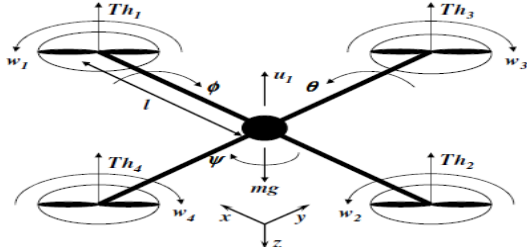

Fig.1. Theoretical Model of Quadcopter

where, $X = (x, y, z)$ is the position vector of the quad-rotor.
 $v = (u, v, w)$ is the speed vector of the quad-rotor.
 $\dot{\alpha} = (\dot{\psi}, \dot{\theta}, \dot{\phi})$ the Euler angles (for pitch, roll and yaw respectively).
 $\omega = (p, q, r)$ is the angular speed vector.

Two coordinate systems are required to define at any time the instantaneous state of the platform. First, a fixed system with the x-axis along the front, the z-axis down and the y-axis to the right of the craft. Second, an earth fixed inertial system using the convention type of aviation applications. The one frame rotation relative to the other can be described by rotation matrix, which comprise of three independent matrices and describes the rotation of craft about every single earth frame axes. These rotation matrices can be written as follows.

$$\left. \begin{aligned} R_{\theta} &= \begin{bmatrix} 1 & 0 & 0 \\ 0 & \cos\theta & \sin\theta \\ 0 & -\sin\theta & \cos\theta \end{bmatrix} \\ R_{\phi} &= \begin{bmatrix} \cos\theta & 0 & -\sin\theta \\ 0 & 1 & 0 \\ \sin\theta & 0 & \cos\theta \end{bmatrix} \\ R_{\psi} &= \begin{bmatrix} \cos\psi & \sin\psi & 0 \\ -\sin\psi & \cos\psi & 0 \\ 0 & 0 & 1 \end{bmatrix} \end{aligned} \right\} \quad (1)$$

The total rotation matrix equation can be calculated by product of above matrices:-

$$\vartheta = R_{\theta} R_{\phi} R_{\psi} \quad (2)$$

This gives the resultant as shown in the equation 3.

$$R_{xyz} = \begin{bmatrix} C_{\phi} C_{\theta} & C_{\phi} S_{\theta} S_{\psi} - S_{\phi} C_{\psi} & C_{\phi} S_{\theta} C_{\psi} + S_{\phi} S_{\psi} \\ C_{\phi} S_{\theta} & S_{\phi} S_{\theta} S_{\psi} + C_{\phi} C_{\psi} & S_{\phi} S_{\theta} C_{\psi} - C_{\phi} S_{\psi} \\ -S_{\theta} & C_{\theta} S_{\psi} & C_{\theta} C_{\psi} \end{bmatrix} \quad (3)$$

Where $S_{\theta} = \sin(\theta)$, $C_{\psi} = \cos(\psi)$, and R is the matrix transformation. Using equation (3), we can rotate the quadcopter around x, y & z axis. In this work, a simplified model of quad-copter is used. While modelling the quad-copter following assumptions are being made:

1. The structure of quad-rotor is symmetrical and rigid.
 2. The value of Inertia matrix (I) of vehicle is negligible and to be neglected.
 3. The propellers are not flexible.
 4. Drag and thrust are proportional to the square of the propellers speed.
- The equation of motion can be written using the force and moment balance as represented by equation 4.

$$\left. \begin{aligned} \ddot{x} &= (u_1(\cos\phi \sin\theta \cos\psi + \sin\phi \sin\psi) - k_1 \dot{x}) \\ \ddot{y} &= (u_1(\sin\phi \sin\theta \cos\psi - \cos\phi \sin\psi) - k_2 \dot{y})/m \\ \ddot{z} &= (u_1(\cos\phi \cos\psi - g) - k_3 \dot{z})/m \end{aligned} \right\} \quad (4)$$

The K_i 's are the drag coefficients. Here, drag is assumed to be zero as drag is negligible at low speeds. When the centre of gravity moves, the angular acceleration becomes less sensitive to the forces, therefore stability is increased. This will decrement the roll and pitch moments and also the total vertical thrust. The inputs can be represented by equation. 5.

$$\left. \begin{aligned} U_1 &= (Th_1 + Th_2 + Th_3 + Th_4)/m \\ U_2 &= I(-Th_1 - Th_2 + Th_3 + Th_4)/I_1 \\ U_3 &= I(-Th_1 + Th_2 + Th_3 - Th_4)/I_2 \\ U_4 &= C(Th_1 + Th_2 + Th_3 + Th_4)/I_3 \end{aligned} \right\} \quad (5)$$

Euler angles equations are given by equation. 6

$$\left. \begin{aligned} \ddot{\theta} &= u_2 - lk_4 \dot{\theta}/I_1 \\ \ddot{\psi} &= u_3 - lk_5 \dot{\psi}/I_2 \\ \ddot{\phi} &= u_4 - lk_6 \dot{\phi}/I_3 \end{aligned} \right\} \quad (6)$$

Here,

Th_i , for $i = 1$ to 4 are the thrust of four motors of quadcopter.
 I_i , for $i = 1$ to 3 are the moments of inertia of the craft with respect to the axes.
 K_i , for $i = 1$ to 3 are the drag coefficients with centre of gravity assumed to be on the origin.

All states cannot be controlled simultaneously. A possible combination of controlled outputs can be x, y, z and a good controller must reach a desired yaw angle and position while keeping the pitch and roll angles constant. Theta (θ_d) and Pitch (ψ_d) can be extracted by the equations 7 & 8 respectively.

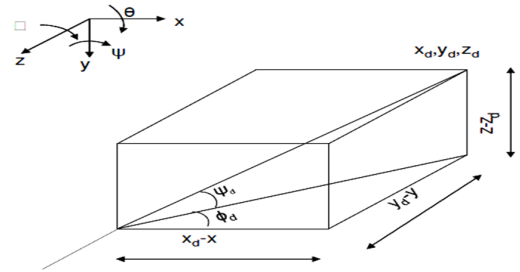

Fig. 2. The quad-rotor angle movement

$$\theta_d = \tan^{-1} \left(\frac{y_d - y}{x_d - x} \right) \quad (7)$$

$$\psi_d = \tan^{-1} \left(\frac{z_d - z}{\sqrt{(x_d - x)^2 + (y_d - y)^2}} \right) \quad (8)$$

The overall Simulink model of the quadcopter model is shown in Fig. 3.

III. MODIFIED GENETIC ALGORITHM

GAs are based on natural genetics and selection. These are random but intelligent search techniques used to solve optimization problems. Basic flow chart of GA consists of following steps :-

1. Population is randomly initialized
2. Fitness of population is determined.
3. Above two steps are repeated again and again.
4. Select parents from population.
5. Perform crossover & mutation on parents creating next population
6. Step 2 to 5 are repeated until best individual is good enough (satisfying termination criteria).

Further ability of canonical genetic algorithm can be improved by modifying it as follows:

1. Adaptation of crossover and mutation rate.
2. Enhancement of element of randomness.

To increase the speed of convergence of GA, crossover fraction and mutation rates are made adaptive and for this, two fuzzy logic controllers; i.e. crossover fuzzifier & mutation fuzzifier are used as shown in Fig. 4. The inputs to both the fuzzy sets are ΔF_s1 & ΔF_s2 respectively i.e. changes in fitness values obtained with GA, as defined by equation 9. Here $F_s(g)$, $F_s(g-1)$ & $F_s(g-2)$ denote the fitness function of genetic algorithm during last three generations. Depending upon the changes in the fitness values, FLC decides the changes in the crossover & mutation rate i.e. it makes crossover fraction & mutation rate adaptive [12].

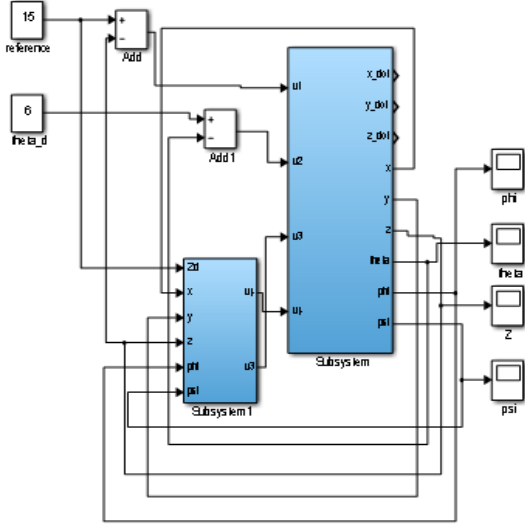

Fig. 3. Simulink model of overall quadcopter

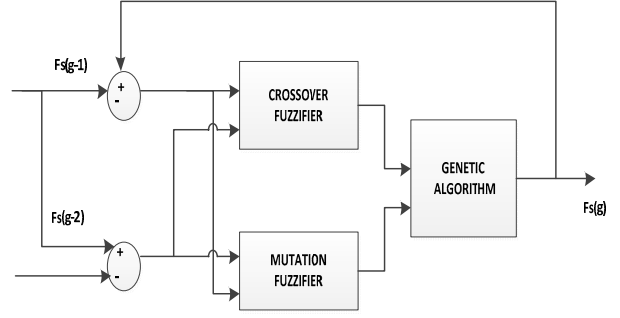

Fig. 4. Adaptation of Mutation & Crossover rate

Shape of membership function of input variables for mutation and crossover fuzzifier are given in Fig. 5.

$$\Delta F_s1 = F_s(g) - F_s(g-1) \quad (9)$$

$$\Delta F_s2 = F_s(g-1) - F_s(g-2) \quad (10)$$

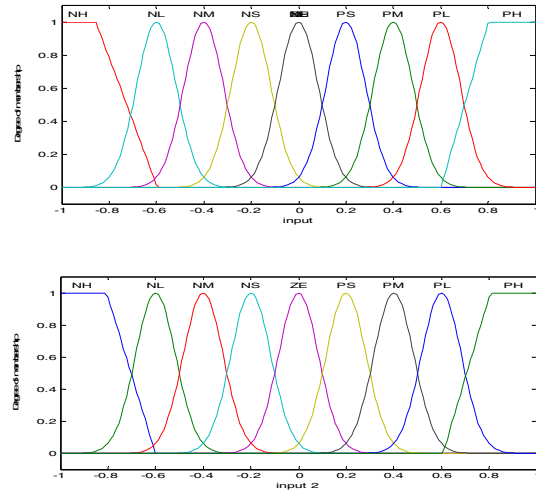

Fig. 5. Shape of mfs for input variables of crossover and mutation fuzzifier

Output variable is represented by seven equi-spaced triangular membership functions between -1 & 1. FLC decides the required change in the crossover & mutation rate depending on the change/ rate of change of the fitness function during last three generations.

More randomness to Genetic Algorithm is induced by randomly adding a few new members after specific number of generations of GA. The complete steps of working of improved GA are given in Fig. 6.

In this work, the parameters of PID controller used for quad-copter control i.e. K_p , K_i & K_d have been tuned both using canonical as well as improved Genetic Algorithm. For this purpose, a population size of 30 is taken (= 10 times the value of parameter to be optimized) Other parameters of canonical GA have been specified in the table 1.

Here, Mp_1 , tr_1 & $IISSEE$ represent maximum overshoot, rise time & Integral Square of error. Hence, the fitness function is based upon the transient state & steady state performances. The coefficients of fitness function have been decided by hit & trial. The optimization problem is repeated with the improved GA as shown in Fig.7.

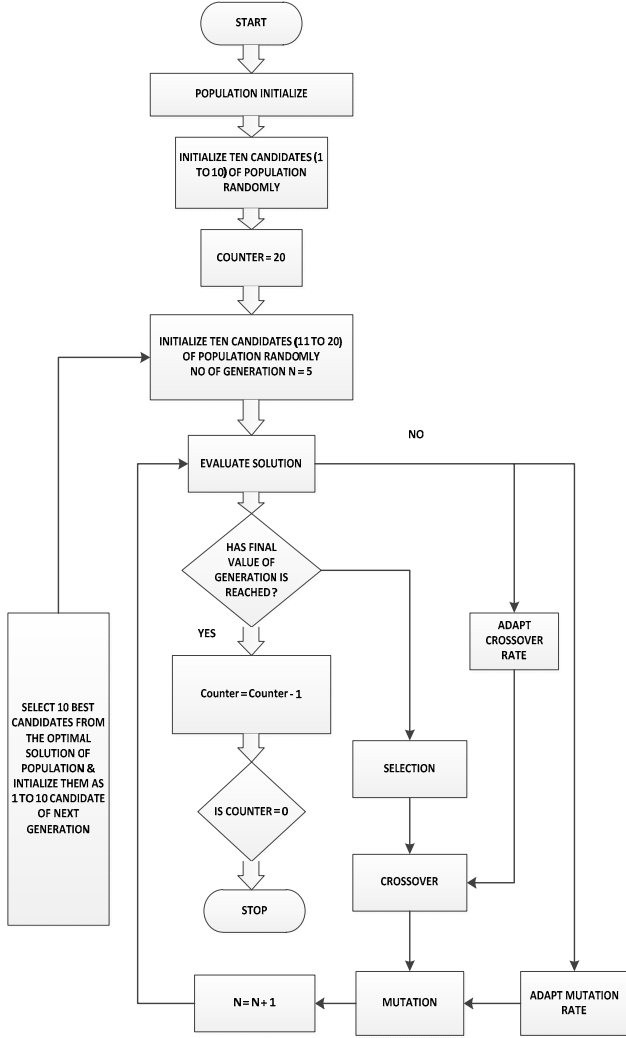

Fig. 6. Working of Modified GA

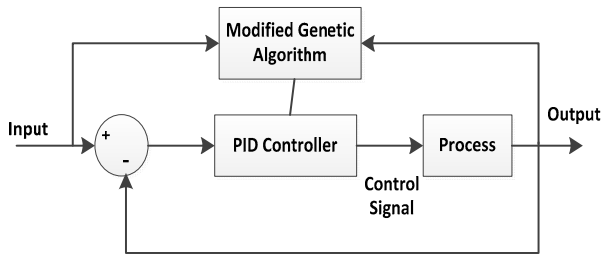

Fig. 7. PID tuning using Modified GA

TABLE I. PARAMETERS OF GA USED TO TUNE PID CONTROLLER

S. No	Parameters	Values	Comments
1.	No. of Generations	100	N.A
2.	Type of Coding	N.A.	Real Coding
3.	Population Size	30	N.A
4.	Selection Function	N.A.	Stochastic Uniform
5.	Stopping Criteria	Fitness fun. tolerance = .001, during last 3 generations.	Fitness limit
6.	Fitness function	N.A.	$3.5 * Mp_1 + 1.5 * tr_1 + IISSEE$

IV. SIMULATION RESULTS

The optimal PID controllers have been used for quadrotor control using MATLAB Simulink. As represented in performance curves of fig. 8, 9, 10, 11 & Table 2, the PID controller tuned by improved Genetic Algorithms outperforms the other controllers with minimal or no overshoot, very less settling time and zero steady state error.

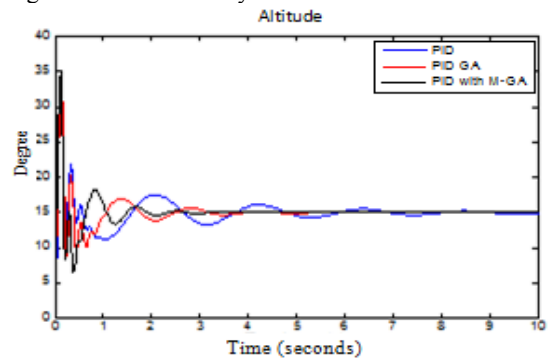

Fig. 8. Comparison of results for Altitude

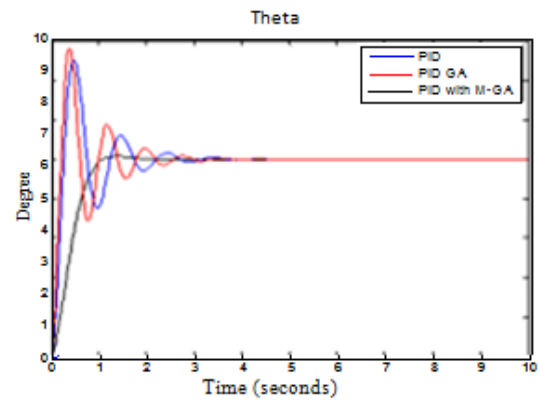

Fig. 9. Comparison of results for Pitch (Theta)

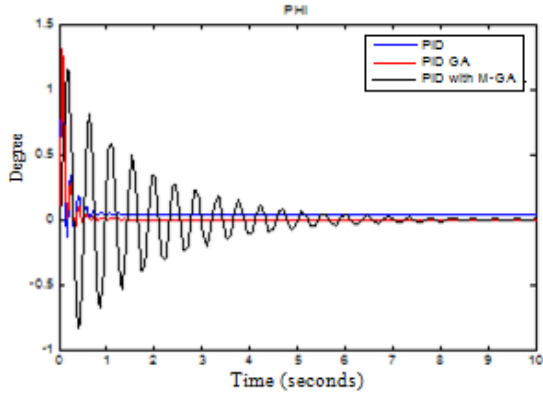

Fig.10. Comparison of results for Roll (Phi)

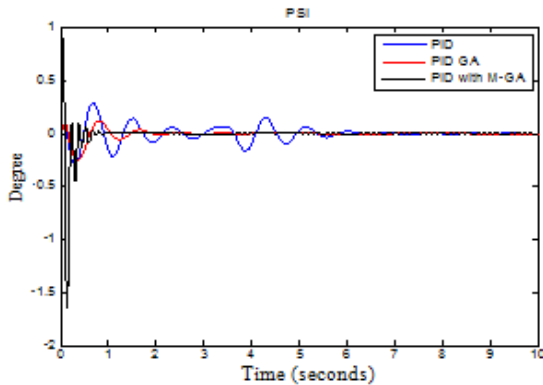

Fig.11. Comparison of Results for Yaw (Psi)

TABLE II. COMPARATIVE ANALYSIS

S. No	PARAMETERS	PID		PID TUND WITH GA		PID TUNED WITH GA	
		t_s	t_{ss}	t_s	t_{ss}	t_s	t_{ss}
1.	Altitude	9.1	11	3.2	5	2.8	3.1
2.	Pitch (θ)	5.8	5.1	3.1	4.5	2	2.5
3.	Roll (Φ)	4.1	7	2	2.5	1	1.2
4.	Yaw (Ψ)	7	NA	1.3	2	1.2	1.5

Where ;

t_s - Settling Time

t_{ss} - Steady State Time

V. CONCLUSION

In this work, quadrotor dynamics has been simulated in MATLAB Simulink environment. An effort is made to control the dynamics of four output variables i.e. altitude, pitch angle, yaw angle & roll angle. For this purpose, PID controller is used. The parameters of this controller have been tuned with genetic algorithm. An improved GA is proposed to improve the search ability of conventional GA. It is observed after number of simulation run that performance out of PID controller tuned with proposed modified GA is more optimized.

REFERENCES

- [1] Bouabdallah, S. et al. (2004), "Design and Control of an Indoor Micro Quadrotor", *Proc. (IEEE) International Conference on Robotics and Automation (ICRA'04)*, New Orleans, USA, 2004.
- [2] Derafa, L., Benallegue, A. and Fridman, L. (2012), "Super Twisting Algorithm for the Attitude Tracking of a Four Rotors UAV", *Journal of Franklin Institute*, pp. 685–699.
- [3] Bouabdallah, S., Noth, A. and Siegwart, R. (2004), "PID vs. LQ Control Techniques Applied to an Indoor Microquadrotor", *Proc. of IEEE/RSJ Int.conf. on intelligent Robots and Systems*, 2004, (IROS 2004), Vol. 3, pp. 2451–2456.
- [4] Li, J. and Li, Y. (2011), "Dynamic Analysis and PID Control for a Quadrotor", *IEEE International Conference on Mechatronics and Automation*, pp. 573–578.
- [5] Achtelek, M., Zhang, Tianguang, Kuhnlenz, K. and Buss, M. (2009), "Visual Tracking and Control of a Quadcopter using a Stereo Camera System and Inertial Sensors", *International Conference on Mechatronics and Automation*, pp. 2863–2869, 9-12 Aug. 2009.
- [6] Kumar, S. and Negi, R. (2012), "A Comparative Study of PID Tuning Methods using Anti-windup Controller", *2nd International Conference on Power, Control and Embedded Systems (ICPCES)*, pp. 17–19, Dec. 2012.
- [7] Kumari, M. Sailaja and Sydulu, M. (2009), "A Fast Computational Genetic Algorithm for Economic Load Dispatch", *International Journal of Recent Trends in Engineering*, Vol. 1, No. 1, pp. 349–356, May 2009.
- [8] Salih, Atheer L., Moghavvemi, M., Mohamed, Haider A.F. and Gaeid, Khalafat Sallom (2010), "Flight PID Controller Deign for a UAV Quadrotor", *Scientific Research and Essay*, Vol. 5(23), pp. 3660–3667, 4 December, 2010.
- [9] Jayachitra, A. and Vinodha, R. (2010), "PID Controller Tuning using GA, EP, PSO and ACO", *IEEE International Conference on, Communication Control and Computing Technologies (ICCCCT)*, pp. 305–313, 7-9 Oct. 2010.
- [10] Saini, J.S., Gopal, M. and Mittal, A.P. (2004), "Evolving Optimal Fuzzy Logic Controllers by Genetic Algorithms", *IETE Journal of Research*, Vol. 50, No. 3, pp. 179–190, May-June 2004.
- [11] Kaur, Arunpreet, Singh, Harinder Pal and Bhardwaj, Abhishek (2014), "Analysis of Economic Load Dispatch Using Genetic Algorithm", *International Journal of Application or Innovation in Engineering & Management (IJAIEM)*, ISSN: 2319-4847, Vol. 3, Issue 3, March 2014.
- [12] Liao, Gwo-Ching and Ta-peng Tsao (2006), "Using Chaos Search Immune Genetic and Fuzzy System for Short-term Unit Commitment Algorithm", Department of Electrical Engineering, National SunYa-Sen University, *Electrical Power and Energy Systems*, Vol. 28, No. 1, pp. 1–12.
- [13] Zhou, Hongbo, Pei, Hailong and He, Yuebang (2012), "Small Unmanned Helicopter Flight Controller Design by use of Integral MPC and Adaptive Backstepping", *31st Chinese Control Conference (CCC)*, pp. 312–31, 25-27 July 2012.
- [14] Pyrkin, Anton A. and Bobtsov, Alexey A. (2014), "Output Controller for Quadcopters Based on Mathematical Model Decomposition", *IEEE Mediterranean Conference on Control and Automation*.
- [15] Quan, Q., Du, G. and Cai, K. (2016), "Proportional-Integral Stabilizing Control of a Class of MIMO Systems Subject to Nonparametric Uncertainties by Additive-State-Decomposition Dynamic Inversion Design", *IEEE/ASME Transaction on Mechatronics*, Vol. 21, Issue 2, pp. 1092–1101, April 2016.
- [16] Chen, F., Wu, Q., Jiang, B. and Tao, G. (2015), "A Reconfiguration Scheme for Quadrotor Helicopter via Simple Adaptive Control and Quantum Logic", *IEEE Transaction on Industrial Electronics*, Vol. 62, No. 7, pp. 4328–4335, July 2015.
- [17] Fakurian, F., Menhaj, M.B. and Mohammadi, A. (2014), "Fuzzy Controller Design for Quadrotor Uavs using Minimal Control Input", *Indian J. Sci. Res.*, Vol. 1(2), pp. 157–164, July 2014.
- [18] Michalewicz, Z. et al. (1992), "A Modified Genetic Algorithm for Optimal Control Problems", *Computers Math. Applications*, Vol. 23, No. 12, pp. 83–94.